

# OPERATOR'S MANUAL

## **INVACARE® FREEWAY® FREEDOM AEROSOL COMPRESSOR MODEL IRC1175**

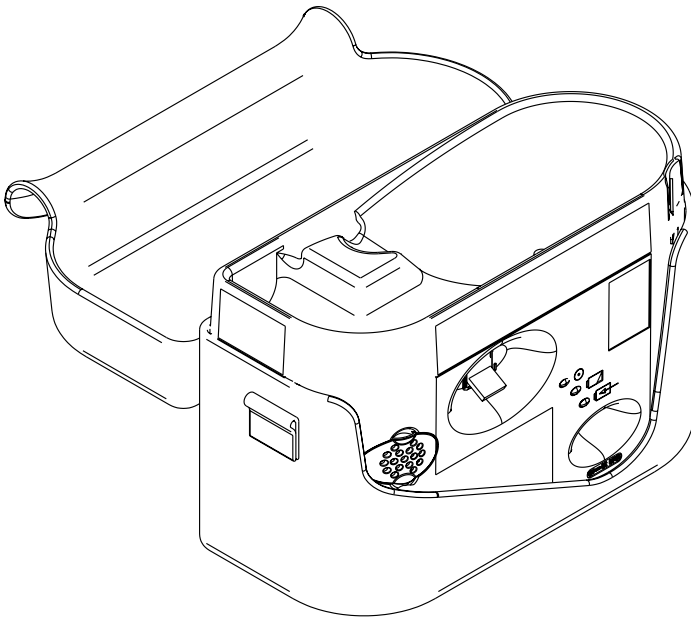

**DEALER:** THIS MANUAL MUST BE GIVEN TO THE END USER.

**USER:** BEFORE USING THIS COMPRESSOR, READ THIS MANUAL AND SAVE FOR FUTURE REFERENCE.



*Yes, you can.™*

## **SPECIAL NOTES**

**DANGER/WARNING/CAUTION** notices as used in this manual apply to hazards or unsafe practices which could result in personal injury or property damage.

### **NOTICE**

**THE INFORMATION CONTAINED IN THIS DOCUMENT IS SUBJECT TO CHANGE WITHOUT NOTICE.**

**THIS AEROSOL COMPRESSOR IS INTENDED FOR HOUSEHOLD USE.**

## **WARNING**

**DO NOT** install, maintain or operate this equipment without first reading and understanding this manual. If you are unable to understand the **DANGERS / WARNINGS / CAUTIONS** and **INSTRUCTIONS**, contact a healthcare professional, dealer or technical personnel before attempting to use this equipment - otherwise injury or damage may result.

---

**SAVE THESE INSTRUCTIONS**

# TABLE OF CONTENTS

<b>SPECIAL NOTES</b> .....	2
<b>TABLE OF CONTENTS</b> .....	3
<b>SAFETY SUMMARY</b> .....	4
<b>FEATURES</b> .....	6
<b>SPECIFICATIONS</b> .....	7
<b>INTRODUCTION</b> .....	8
<b>TRAVELING INFORMATION</b> .....	8
<b>THE FREEWAY FREEDOM BATTERY PACK</b> .....	9
Installing the Freeway Freedom Battery Pack .....	9
Initial Battery Charging .....	10
Normal Battery Charging Procedures .....	10
<b>OPERATION</b> .....	11
Explanation of Power Indicator Lights .....	11
Power Supply Options .....	11
Operation from the Wall Outlet .....	12
Operating from the Freeway Freedom Battery Pack .....	12
Operating from a Car or a Boat .....	12
Preparing for Treatment .....	13
Taking the Treatment .....	15
After the Treatment .....	16
<b>MAINTENANCE</b> .....	17
Prolonging the Life of your Battery .....	17
Cleaning the Freeway Freedom .....	18
Cleaning the Sidestream Nebulizer .....	19
Replacing the Air Filter .....	19
Fuse Replacement .....	20
Servicing .....	20
Accessories and Spare Parts .....	20
<b>TROUBLESHOOTING</b> .....	21
<b>LIMITED WARRANTY</b> .....	22

# **SAFETY SUMMARY**

## **CAUTION**

"Caution: Federal law restricts this device to sale or rental by or on order of a physician, or any other practitioner licensed by the law of the state in which he practices to use or order the use of this device."

Risk of electric shock. **DO NOT** disassemble. Refer servicing to qualified service personnel.

**READ THE FOLLOWING INFORMATION BEFORE OPERATING THIS PRODUCT.**

When using electrical products, especially when children are present, basic safety precautions should always be followed, including the following:

## **DANGER**

**TO REDUCE THE RISK OF ELECTROCUTION:**

Always unplug this product **IMMEDIATELY** after using.

**DO NOT** use while bathing.

**DO NOT** place or store product where it can fall or be pulled into a tub or sink.

**DO NOT** reach for product that has fallen into water. **UNPLUG IMMEDIATELY.**

**DO NOT** place in or drop into water or liquid.

## **WARNING**

**TO REDUCE THE RISK OF BURNS, ELECTROCUTION, FIRE OR INJURY TO PERSONS:**

Close supervision is necessary when this product is used by, on or near **CHILDREN OR PHYSICALLY CHALLENGED INDIVIDUALS.**

---

**WARNING**

**DO NOT** operate unit longer than twenty (20) minutes **CONTINUOUSLY**. Allow forty (40) minutes for the unit to cool before operating again.

Use this product only for its intended use as described in this manual. Use this product **ONLY** under a physician's direction. **DO NOT** use attachments **NOT** recommended by the manufacturer.

**NEVER** operate this aerosol compressor if it has a damaged cord or plug, if it is **NOT** working properly, if it has been dropped or damaged, or dropped into water; call a qualified technician for examination and repair.

Keep the cord away from **HEATED** or **HOT** surfaces.

**NEVER** drop or insert any object into any opening.

**NEVER** use while sleeping or drowsy.

**DO NOT** operate where aerosol (spray) products are being used or where oxygen is being administered in a closed environment such as an oxygen tent.

This unit is oil-less. **DO NOT** lubricate.

**DO NOT** operate in the rain or other wet environments.

---

# FEATURES

## FEATURES

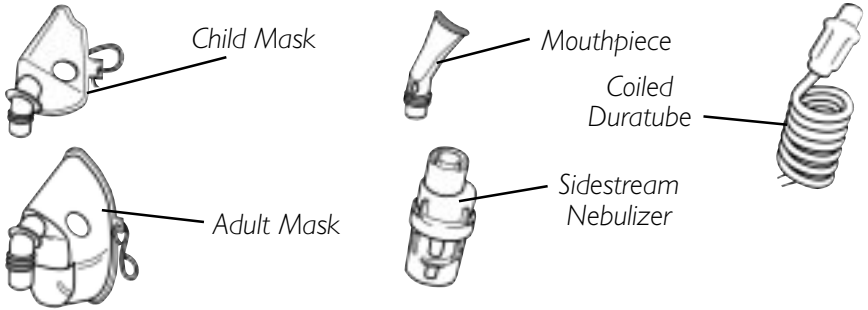

**NOTE:** There is a medication pocket and an identification tag on the inside flap of the carrying case. Your nebulizer, mask or mouthpiece may be stored in the storage compartment.

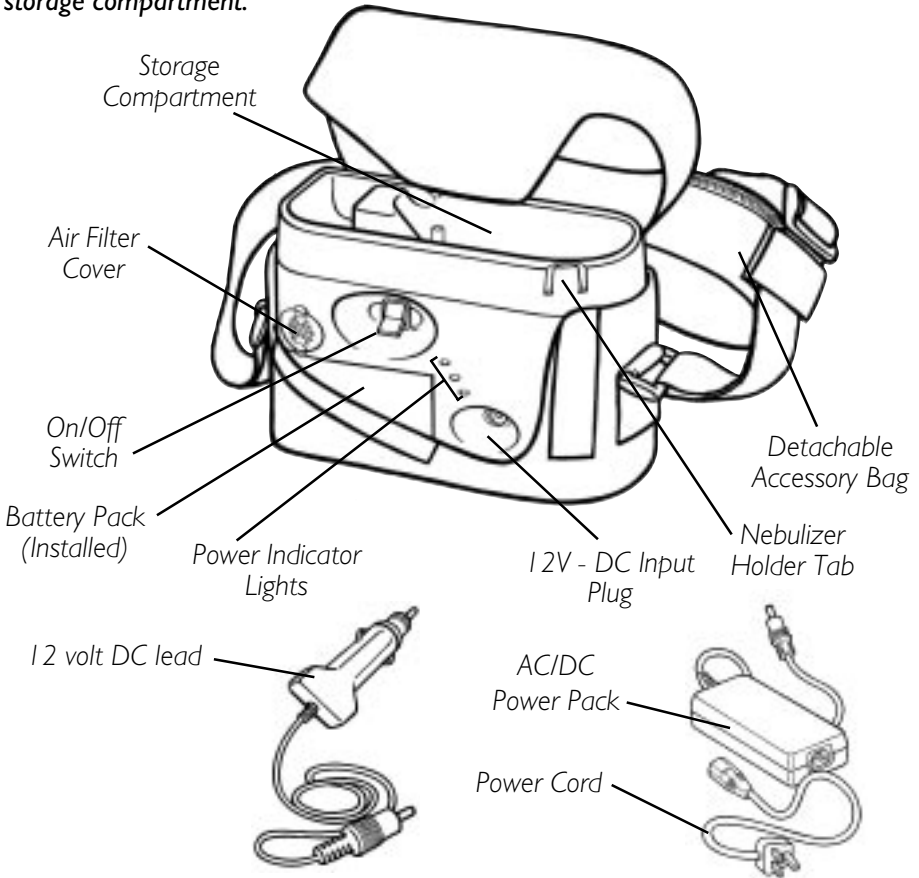

**NOTE:** The 12 volt DC lead, AC/DC power pack and power cord may be stored in the detachable accessory bag.

# **MODEL IRC I 175 SPECIFICATIONS**

**Electrical Requirements:** 90-240 VAC, 50-60 Hz, or  
12 -14 VDC **===**

**Ambient Temperature**

**Range:** 10° C - 40° C (50° F - 104° F)

*NOTE: Operating at extreme temperatures may increase treatment times.*

**Power Wattage:** 24 Watts, @ 11 ± 1 PSI

**Thermal Protector:** Internal Solid State - Auto Resettable

*NOTE: The Freeway Freedom unit and Battery Pack each have an internal resettable thermal fuse in case of overheating (operating longer than 20 minutes) or using incorrect polarity DC jack.*

**Safety Systems:** Class II - Double Insulated 

Type BF 

**Fuse:** T3 Amp Fuse

**Intake Filter:** 300 micron, polyethylene

**Flowrate:** Flowrate (typical): 6 lpm with Sidestream nebulizer-model # MS2400 (back pressure approximately 9.5 +/- .5 PSI)

**Width:** 9.25-inches

**Height:** 6.5-inches

**Depth:** 4.5-inches (7.5-inches w/accessory bag)

**\*Weight:** 3.4 lbs (5.2 lbs. w/all accessories)

**Battery Pack Dimensions:** 3.75 x 1.4 x 2.4-inches

**IMPORTANT DC Inlet**

**Polarity:** External Positive +  - Internal Negative

**\* Weights given include the 1.1 lb. removable battery.**

**=== Stands for Direct Current**

# **INTRODUCTION**

Freeway Freedom is different than other aerosol compressors because it is smaller, lighter and quieter. It has the added benefit of having batteries for complete portability.

1. Carefully unpack your Freeway Freedom. Keep the box as this may be required when returning it for servicing.
2. The battery pack will need to be charged before use. Refer to INITIAL BATTERY CHARGING in the OPERATION section of this manual.
3. The Sidestream nebulizer must be boiled in water before the first use. Refer to CLEANING THE SIDESTREAM NEBULIZER in the MAINTENANCE section of this manual.
4. Read these instructions completely before use.
5. Observe recommendations for maintenance and replacement.

# **TRAVELING INFORMATION**

*NOTE: The Freeway Freedom Aerosol Compressor uses nickel metal hydride batteries which are accepted for use on most airlines. However, we strongly advise that you contact your airline before travel to ensure their approval.*

The AC/DC Power Pack and cord are designed to operate from U.S. and North American outlet voltages and plug configurations (90 - 240 VAC, 50 - 60Hz). By purchasing travel plug adaptors, the Freeway Freedom can be utilized around the world.



# **THE FREEWAY FREEDOM BATTERY PACK**

The Freeway Freedom battery pack contains nickel metal hydride (NiMH) cells. Refer to PROLONGING THE LIFE OF THE BATTERY in the MAINTENANCE section of this manual.

A second battery pack may be purchased for emergency purposes or if extra power is required for more treatments (e.g. on a long airplane flight) between charges.

## **INSTALLING THE FREEWAY FREEDOM BATTERY PACK (FIGURE I)**

1. Remove the protective film covers (plastic tape) from the battery terminals before installing the Freeway Freedom battery pack.
2. Install the Freeway Freedom battery pack into the bottom of the Freeway Freedom as shown in FIGURE I.

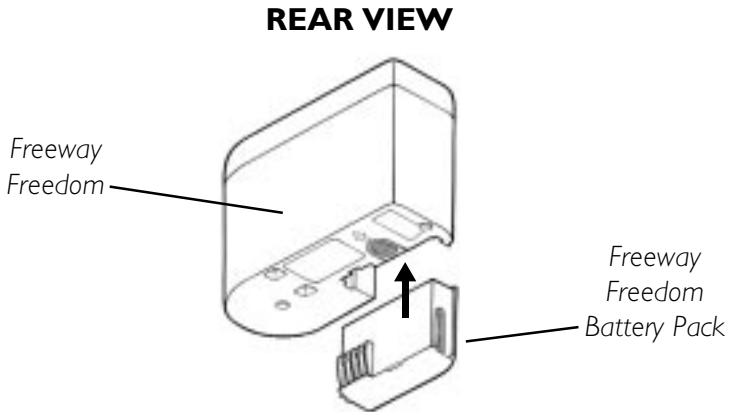

**FIGURE I - INSTALLING THE FREEWAY FREEDOM  
BATTERY PACK**

## INITIAL BATTERY CHARGING

To maximize the capacity and life of the Freeway Freedom rechargeable batteries, FULLY charge them for 16 hours before initial use.

1. FULLY discharge the batteries by running the unit 20 minutes ON ( I ) then 40 minutes OFF ( O ) until the unit no longer runs. Repeat cycle two (2) to three (3) times.
2. Next FULLY charge the batteries for 16 hours. Now the unit is ready for regular use with the batteries.

*NOTE: Refer to NORMAL BATTERY CHARGING PROCEDURES in this manual for charging procedures.*

## NORMAL BATTERY CHARGING PROCEDURES

The Freeway Freedom internal control circuit regulates the battery charging. The Freeway Freedom battery pack can be charged for as long as you require without damage. It will take approximately 16 hours to recharge a fully discharged battery.

*NOTE: A FULLY charged battery should provide approximately 36 minutes of treatment time between charges.*

1. Ensure that the ON/OFF switch is in the OFF ( O ) position.
2. If not already installed, attach the battery pack to the Freeway Freedom. Refer to INSTALLING THE FREEWAY FREEDOM BATTERY PACK section in this manual.

### CAUTION

**Your power supply at the DC inlet MUST BE the correct polarity (Refer to SPECIFICATIONS in this manual). The Freeway Freedom will NOT charge batteries from an incorrect polarity DC supply.**

---

3. Connect the AC/DC power pack or 12 volt DC lead to the DC power inlet on the Freeway Freedom and connect the other end to a suitable power supply (wall or car outlet). The GREEN Charging indicator light (  ) will come ON to show that the unit is charging.

# OPERATION

## EXPLANATION OF POWER INDICATOR LIGHTS

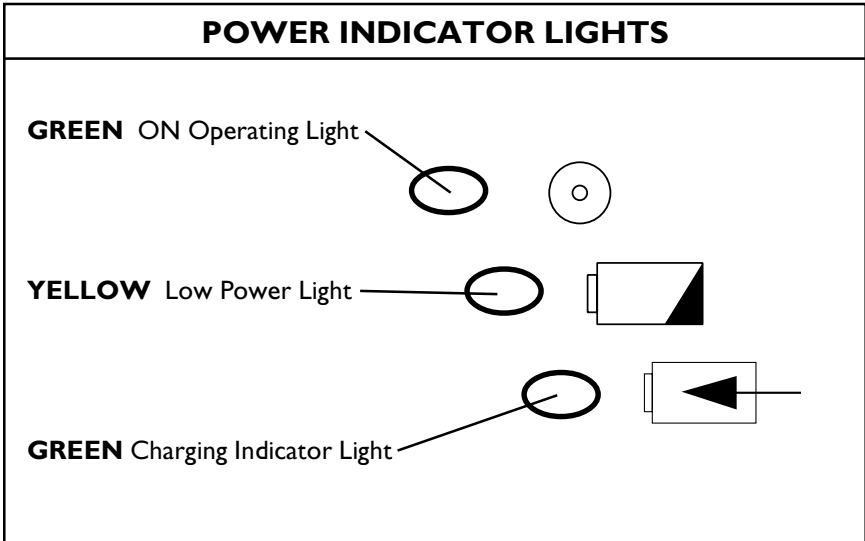

## POWER SUPPLY OPTIONS

Freeway Freedom may be operated from three (3) different sources:

1. The wall outlet, using the Freeway Freedom AC/DC power pack.
2. Freeway Freedom battery pack.
3. A 12 volt DC source (such as a car or boat).

### CAUTION

**DO NOT** plug or unplug the 12 volt lead or AC/DC power pack into the DC inlet when the ON/OFF switch is in the ON ( I ) position, otherwise damage or injury may occur.

## **OPERATION**

---

### **OPERATION FROM THE WALL OUTLET**

The Freeway Freedom power pack is required for running the Freeway Freedom from AC wall outlets and to recharge the batteries when not in use. Your AC/DC power pack and cord are designed to operate from U.S. and North American outlet voltages and plug configurations (90 - 240 VAC, 50 - 60Hz). By purchasing travel plug adaptors, the Freeway Freedom can be utilized around the world.

1. Ensure that the ON/OFF switch is in the OFF (O) position.
2. Connect the Freeway Freedom AC/DC power pack to the power cord.
3. Plug the power cord into the wall and the power pack outlet lead into the Freeway Freedom DC inlet. The GREEN charging indicator light(  ) will come ON.
4. Proceed to PREPARING FOR TREATMENT section in this manual.

### **OPERATING FROM THE FREEWAY FREEDOM BATTERY PACK**

1. Ensure the AC/DC power pack or 12 volt lead is NOT plugged into the control unit panel of the Freeway Freedom.
2. Ensure that the ON/OFF switch is in the OFF ( O ) position.
3. Insert the charged Freeway Freedom battery pack into the unit. Refer to INSTALLING THE FREEWAY FREEDOM BATTERY PACK section in this manual.
4. Proceed to the PREPARING FOR TREATMENT section in this manual.

### **OPERATING FROM A CAR OR A BOAT**

The Freeway Freedom's 12 volt lead will fit into the majority of car cigarette lighter sockets. The vehicle **MUST BE** a negative ground system. This is normal on practically all modern vehicles. Connection to a positive ground system cannot damage the Freeway Freedom, the unit simply will NOT operate or charge the battery from an incorrect polarity DC supply.

---

**CAUTION**

If the unit does **NOT** operate, **IMMEDIATELY** disconnect the power supply from the **DC** inlet and check for correct polarity (Refer to **SPECIFICATIONS** in this manual).

---

*NOTE: Battery alligator clips can be purchased from an electronics retail supply company. These connect the cigarette lighter plug of the DC lead directly to a 12 volt DC battery instead of using a cigarette lighter.*

1. Ensure that the ON/OFF switch is in the OFF ( O ) position.
2. Plug the 12 volt DC lead into the DC inlet.
3. Connect the 12 volt DC lead to the power supply. The GREEN Charging indicator light (  ) will now come ON.
4. Proceed to the **PREPARING FOR TREATMENT** section in this manual.

**PREPARING FOR TREATMENT (FIGURE 2)**

The nebulizer kit contains all the accessories that you need for your treatment.

---

**WARNING**

**DO NOT** begin a treatment when **YELLOW LOW POWER** light (  ) is illuminated. Charge the battery or use another power source.

---

*NOTE: The Freeway Freedom has been designed to be used with the Sidestream Nebulizer. Treatment times will increase if nebulizing antibiotics or using a different nebulizer.*

1. Place the nebulizer in the nebulizer holder tab provided while filling with medication or when resting during treatment.

---

**CAUTION**

**DO NOT** fill the Sidestream nebulizer near the control panel. Spilled liquid may damage the unit.

---

2. Dispense your prescribed medication either directly into the top of the Sidestream nebulizer, or into the base by unscrewing the chamber. Refer to nebulizer instructions.
-

## OPERATION

---

3. Connect the long hose end of the coiled duratube to the inlet on the bottom of the Sidestream nebulizer.
4. Connect either the mouthpiece (supplied) or face mask (supplied) to the Sidestream nebulizer.

*NOTE: Freeway Freedom is designed to nebulize 2.5 - 5cc of medication, 3 to 4 times each day.*

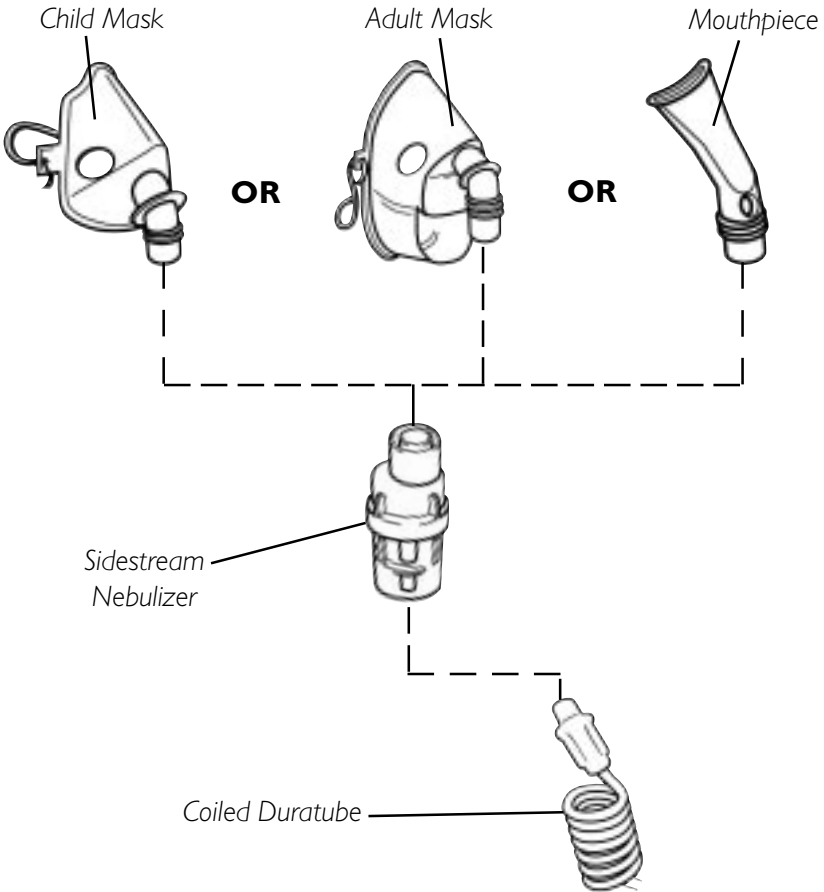

**FIGURE 2 - PREPARING FOR TREATMENT**

## **TAKING THE TREATMENT**

### **CAUTION**

**DO NOT** use the Freeway Freedom for more than 20 minutes continuously in any one (1) hour. Allow a minimum of 40 minutes rest/cooling time.

**DO NOT** operate the unit in temperatures above 104°F (40°C) or below 50°F (10°C), or place near heat sources such as radiators or fires.

### **WARNING**

**DO NOT** run the Freeway Freedom without an air filter as it may cause permanent damage to the compressor.

1. Turn the Freeway Freedom power switch to the ON ( I ) position and the Sidestream nebulizer will produce a fine mist.

*NOTE: If the Freeway Freedom does NOT operate correctly, refer to the TROUBLESHOOTING section of this manual.*

2. It is suggested that you are as relaxed as possible and are sitting in an upright position to obtain the maximum benefit from the treatment.
3. It is suggested that two (2) or three (3) deeper breaths are interspersed with gentle lower chest breathing.

*NOTE: If you get breathless during treatment, you are probably breathing too quickly. If you want to take a short break during treatment, switch OFF ( O ) the Freeway Freedom and resume treatment after your break.*

*NOTE: During use, the Freeway Freedom's battery is prevented from being discharged to a level that would cause permanent damage. If the YELLOW LOW POWER light (  ) comes ON during treatment, finish the treatment. This normally indicates that between 20 to 50% of the operating time is left. This actual time will vary with each unit and the light will illuminate earlier as the batteries age.*

4. When the Sidestream nebulizer begins to work intermittently and “spits”, then the treatment has finished. There is no need to nebulize every drop of your medication as there will always be a small amount left in the chamber.

## OPERATION

---

### AFTER THE TREATMENT (FIGURE 3)

1. Disconnect the Sidestream nebulizer from the coiled duratube by gently twisting the tubing.
2. Rinse out the Sidestream nebulizer and refill with a little clean water.
3. Reconnect the coiled duratube to the Sidestream nebulizer and run the Freeway Freedom again for a few seconds in order to flush out any of the medication that has become trapped in the nebulizer jets.
4. Turn OFF (O) the Freeway Freedom and disconnect the Sidestream nebulizer from the coiled duratube by gently twisting the tubing.
5. Run your Freeway Freedom for approximately 15 seconds without the Sidestream nebulizer connected to dry out any condensation in the coiled duratube.

#### **CAUTION**

**When cleaning the Sidestream nebulizer (medication chamber), take great care not to damage the jet holes. DO NOT use a cleaning brush, abrasive sponge or pad as this damages the center baffle and seriously affects the performance of the Sidestream nebulizer.**

**NEVER** put paper clips, needles or any other objects into the jet holes.

**NEVER** put the coiled duratube in any liquid.

---

6. Disassemble the Sidestream nebulizer into three (3) pieces: the base, the center baffle and the top as shown in FIGURE 3. Wash Sidestream nebulizer and mask or mouthpiece in warm soapy water, rinse thoroughly and air dry.

*NOTE: Electrical items and any other dry components may be stored in the detachable accessory bag.*

7. When all parts are thoroughly dry, store them in the storage compartment on the top of the Freeway Freedom ONLY.

#### **CAUTION**

**NEVER** store your nebulizer and medication in any other area except the storage section of the carrying case. Liquid medication may seriously damage the compressor.

---



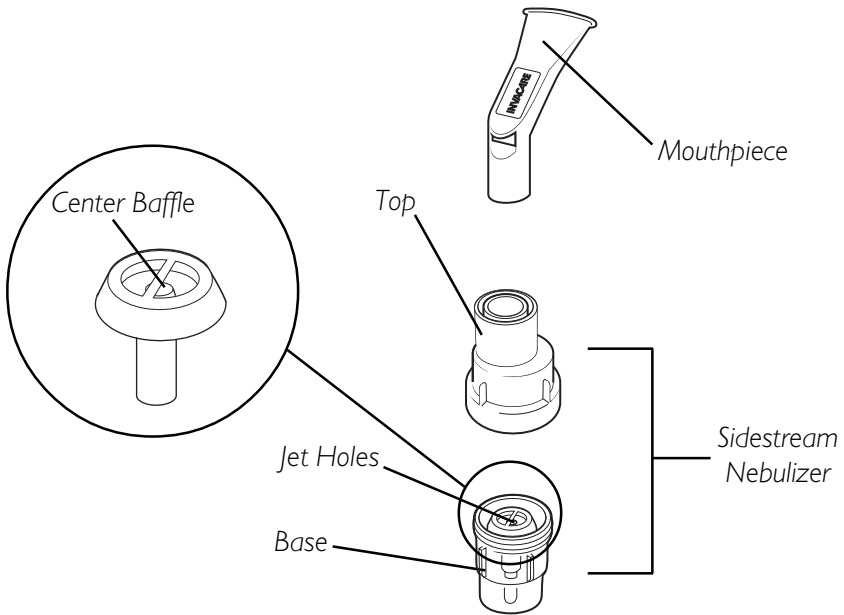

**FIGURE 3 - AFTER THE TREATMENT**

## **MAINTENANCE**

### **PROLONGING THE LIFE OF YOUR BATTERY**

The Freeway Freedom's battery is fully sealed and requires no maintenance. **It should last for approximately 2000 treatments with normal use, but may last even longer if you follow these rules:**

1. Fully discharge the battery at least once a month and fully charge again. This is accomplished by running the Freeway Freedom from the battery until it stops working (approximately 10 to 12 minutes after the **YELLOW LOW POWER** light [  ] illuminates). After the unit is completely discharged, use the AC/DC power pack to fully charge the battery pack (approximately 16 hours).
2. Keep the battery connected to the Freeway Freedom and fully charged at all times. If you own more than one (1) battery pack ensure that it is stored fully charged. It will slowly discharge and after two (2) - three (3) months will be completely discharged.

## MAINTENANCE

---

*NOTE: If you are **not** using the Freeway Freedom for periods longer than one (1) month, remove the battery pack from the device and store separately. The battery pack will slowly lose charge and, dependant upon storage temperature, will be fully discharged after 2-3 months of storage. Once fully discharged the batteries will need to be fully charged (i.e. for 16 hours) and discharged several times to regain full capacity.*

### CAUTION

**Storing an extra battery completely discharged may cause permanent damage to the battery.**

3. Operate your Freeway Freedom from the AC/DC power pack or from a 12 volt DC source whenever possible.
4. Avoid exposure to extreme temperatures.

### WARNING

**DO NOT** operate the unit or charge the batteries in temperatures above 104°F (40°C) or below 50°F (10°C), or place near heat sources such as radiators or fires.

**DO NOT** dispose of the battery pack in the household waste at the end of its useful life (approx. 2000 treatments). Proper disposal at an appropriate collection site provided in your local area is strongly recommended.

## CLEANING THE FREEWAY FREEDOM

### WARNING

**UNPLUG** unit before cleaning.

**DO NOT** submerge in water to clean.

**NEVER** put the coiled duratube in any liquid.

Electrical shock hazard. **DO NOT** remove outer case of this unit. All disassembly and maintenance of this unit **MUST BE** done by a qualified technician.

**DO NOT** wipe the air filter or battery terminals.

Your Freeway Freedom, battery pack and power pack can be cleaned by wiping with a damp cloth.

The carrying case can be machine washed (40°C). Tumble dry at low temperature settings.

### **CLEANING THE SIDESTREAM NEBULIZER**

*NOTE: Refer to AFTER THE TREATMENT in the OPERATING section of this manual for regular use cleaning instructions.*

Initially and once each week your Sidestream nebulizer should be boiled in water with two (2) drops of dish washing liquid for 5 to 10 minutes.

### **REPLACING THE AIR FILTER (FIGURE 4)**

The air filter cleans the air that you use during treatment. The air filter gets dirty over time and will need to be replaced. As soon as the air filter no longer looks white and clean (approximately 3 months) it should be changed.

*NOTE: The air filter will need to be changed more regularly if used in an environment with excessive dirt or smoke.*

1. Remove the air filter cover and the dirty air filter.
2. Insert a clean air filter and replace the air filter cover.
3. Dispose of dirty air filter.

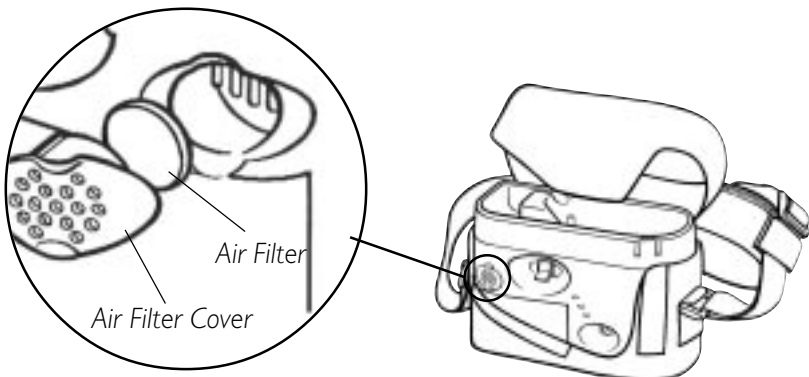

**FIGURE 4 - REPLACING THE AIR FILTER**

## MAINTENANCE

---

### FUSE REPLACEMENT

The 12 volt DC lead (cigarette lighter lead) is fitted with a T3 amp fuse. This is located in the cigarette lighter plug and is removed by unscrewing the end of the cigarette lighter plug body. Replacement fuses can be purchased at your local electronics store.

*NOTE: The Freeway Freedom battery pack and power pack are internally fused and cannot be serviced. If you suspect a fault, contact your local Invacare Dealer for service.*

*NOTE: The Freeway Freedom is fitted with an auto-resetting solid-state PCB fuse. This fuse does NOT require service.*

### SERVICING

Invacare recommends that the Freeway Freedom is serviced by a qualified technician at least once a year.

Accessories should be replaced regularly. It is recommended that all accessories are changed at least once a year, especially the Sidestream nebulizer and the coiled duratube if your Freeway Freedom is being used three (3) or more times a day.

The air filter should be replaced every three (3) months. Refer to **REPLACING THE AIR FILTER** in the **MAINTENANCE** section of this manual for replacement procedure.

If you cannot solve a problem or would like to order any spare parts, please contact your Invacare Dealer.

### ACCESSORIES AND SPARE PARTS

PART NO.	DESCRIPTION
1114879	AC/DC Power Pack
1114883	Freeway Freedom Battery Pack
1114885	Replacement Filters (Qty. 4)
1114882	12V DC Lead (Car Adapter)
1114880	Carrying Case and Detachable Case
1110518	Owner's Manual
2001829	Coiled Duratube Tubing
2001831	Power Cord
MS2400	Reusable Sidestream Nebulizer

# TROUBLESHOOTING

PROBLEM	POSSIBLE SOLUTIONS
Unit does not run from battery.	<ol style="list-style-type: none"> <li>1. Assure battery is installed properly.</li> <li>2. Remove Protective film (tape).</li> <li>3. Check all leads are removed from DC inlet.</li> <li>4. Charge battery for 16 hours.</li> </ol>
Unit does not charge and GREEN Charging indicator is NOT illuminated.	<ol style="list-style-type: none"> <li>1. Confirm power pack is plugged into live wall outlet.</li> <li>2. Have Freeway Freedom serviced by your Dealer.</li> </ol>
Unit does not run from DC inlet.	<ol style="list-style-type: none"> <li>1. Check fuse in DC cigarette lighter lead.</li> <li>2. Check for correct polarity (<b>Refer to SPECIFICATIONS Section in this manual</b>).</li> </ol>
Unit runs slowly or battery usage time decreased.	<ol style="list-style-type: none"> <li>1. Check if filter is clean. Replace.</li> <li>2. Check coiled duratube for blockage. If blocked, replace with new one. DO NOT immerse in water.</li> <li>3. Follow Discharge/Charge directions in "Prolonging the Life of your Battery". (<b>Refer to MAINTENANCE Section in this Manual.</b>) Procedure may need to be repeated.</li> </ol>
Unit runs and Sidestream nebulizer makes poor or no mist.	<ol style="list-style-type: none"> <li>1. Thoroughly clean the nebulizer (<b>Refer to AFTER THE TREATMENT section in this manual.</b>)</li> <li>2. Replace nebulizer with a new one.</li> </ol>

*NOTE: If any of the above problems occur and the solutions do not work, please contact your Invacare Dealer for service.*

## **LIMITED WARRANTY**

**PLEASE NOTE: THE WARRANTY BELOW HAS BEEN DRAFTED TO COMPLY WITH FEDERAL LAW APPLICABLE TO PRODUCTS MANUFACTURED AFTER JULY 4, 1975.**

This warranty is extended only to the original purchaser/user of our products.

This warranty gives you specific legal rights and you may also have other legal rights which vary from state to state.

Invacare warrants the compressor of the Freeway Freedom Aerosol Compressor to be free from defects in materials and workmanship for a period of one (1) year from date of purchase. The nebulizer, mouthpiece, batteries and any other accessories are excluded in this warranty. If within such warranty period any such product shall be proven to Invacare's satisfaction to be defective, product shall be repaired or replaced, at Invacare Respiratory Corporation option. This warranty does not include normal wear and tear or shipping charges incurred in replacement part installation or repair of such product. Invacare's sole obligation and your exclusive remedy under this warranty shall be limited to such repair and/or replacement.

For warranty service, please contact Invacare's Service Department at the Toll Free Number listed (Back Cover) during normal hours.

Upon receiving notice of an alleged defect in a product, Invacare will issue a serialized return authorization. It shall be the responsibility of the purchaser to return, at the purchaser's cost, to either Invacare's plant or service center as specified by Invacare in advance. Defective components part(s) must be returned for warranty inspection using the serial number for identification within 30 days of the return authorization date. **DO NOT** return products to our factory without prior consent. C.O.D. shipments will be refused - please prepay shipping charges.

**LIMITATIONS AND EXCLUSIONS: THE FOREGOING WARRANTY SHALL NOT APPLY TO SERIAL NUMBERED PRODUCTS IF THE SERIAL NUMBER HAS BEEN REMOVED OR DEFACED, PRODUCTS SUBJECTED TO NEGLIGENCE, ACCIDENT, IMPROPER OPERATION, MAINTENANCE OR STORAGE, PRODUCTS MODIFIED WITHOUT INVACARE'S EXPRESS WRITTEN CONSENT (INCLUDING, BUT NOT LIMITED TO, MODIFICATION THROUGH THE USE OF UNAUTHORIZED PARTS OR ATTACHMENTS; PRODUCTS DAMAGED BY REASON OF REPAIRS MADE TO ANY COMPONENT WITHOUT THE SPECIFIC CONSENT OF INVACARE, OR TO A PRODUCT DAMAGED BY CIRCUMSTANCES BEYOND INVACARE'S CONTROL, AND SUCH EVALUATION WILL BE SOLELY DETERMINED BY INVACARE. THE WARRANTY SHALL NOT APPLY TO PROBLEMS ARISING FROM NORMAL WEAR OR FAILURE TO ADHERE TO THE FOLLOWING INSTRUCTIONS.**

**THE FOREGOING EXPRESS WARRANTY IS EXCLUSIVE AND IN LIEU OF ANY OTHER WARRANTIES WHATSOEVER, WHETHER EXPRESSED OR IMPLIED, INCLUDING THE IMPLIED WARRANTIES OF MERCHANTABILITY AND FITNESS FOR A PARTICULAR PURPOSE, AND THE SOLE REMEDY FOR VIOLATIONS OF ANY WARRANTY WHATSOEVER, SHALL BE LIMITED TO REPAIR OR REPLACEMENT OF THE DEFECTIVE PRODUCT PURSUANT TO THE TERMS CONTAINED HEREIN. THE APPLICATION OF ANY IMPLIED WARRANTY WHATSOEVER SHALL NOT EXTEND BEYOND THE DURATION OF THE EXPRESS WARRANTY PROVIDED HEREIN. INVACARE SHALL NOT BE LIABLE FOR ANY CONSEQUENTIAL OR INCIDENTAL DAMAGES WHATSOEVER.**

**SOME STATES DO NOT ALLOW THE EXCLUSION OR LIMITATION OF INCIDENTAL OR CONSEQUENTIAL DAMAGE, OR LIMITATION ON HOW LONG AN IMPLIED WARRANTY LASTS, SO THE ABOVE EXCLUSION AND LIMITATION MAY NOT APPLY TO YOU.**

**THIS WARRANTY SHALL BE EXTENDED TO COMPLY WITH STATE/PROVINCIAL LAWS AND REQUIREMENTS.**



**Yes, you can.™**

**Invacare Corporation**

[www.invacare.com](http://www.invacare.com)

**USA**

One Invacare Way  
Elyria, Ohio USA  
44036-2125  
800-333-6900

699 Aero Lane  
Sanford, Florida  
32771  
Technical Support:  
Toll Free 800-832-4707

Invacare is a registered trademark of Invacare Corporation. Freeway and Sidestream are registered trademarks of the Profile Therapeutics plc group of companies.

Yes, you can. is a trademark of Invacare Corporation.

© 2002 Invacare Corporation  
Part No. 1110518 Rev A 08/02  
UK Part No. RP3753 Issue 1

**Manufactured by:**

Profile Therapeutics plc  
Heath Place  
Bognor Regis  
West Sussex  
PO22 9SL  
UK

[www.profiletherapeutics.com](http://www.profiletherapeutics.com)